

K

monogirante

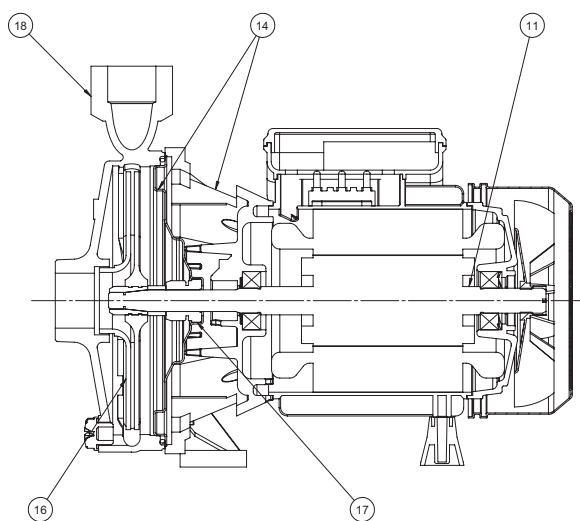

NOMENCLATURA PARTI DI RICAMBIO
 SPARE PARTS LIST
 NOMENCLATURE PIECES DE RECHANGE
 NOMENCLATURA REPUESTOS



- 11 Albero con rotore – Pump shaft + rotor
Arbre + rotor – Eje rotor
- 14 Supporto mandata – Outlet bracket
Support envoyée – Soporte entrega
- 16 Girante – Impeller
Turbine – Impulsor
- 17 Tenuta meccanica – Mechanical seal
Garniture mécanique – Cierre mecánico
- 18 Corpo pompa – Pump body
Corp de pompe – Cuerpo bomba

ELETTROPOMPE CENTRIFUGHE MONOGIRANTE

Le elettropompe centrifughe monogiranti della serie K, sono state progettate per pompare liquidi, senza parti abrasive, senza corpi solidi in sospensione, non esplosivi o aggressivi per i materiali della pompa

- Temperatura max. del liquido fino a 35 °C per uso domestico (CEI EN 60335-2-41) o 90 °C per altri usi e temperatura ambiente fino a 40 °C.
- Portate fino a 18 m³/h.
- Prevalenze fino a ~ 60 m.

CARATTERISTICHE COSTRUTTIVE

- Corpo pompa: ghisa G20 con trattamento anticorrosione
- Supporto motore: alluminio pressofuso UNI 5076 (ghisa per K 150-550)
- Girante: Tecnopolimero (ottone stampato UNI- EN 12165 per K 150-550)
- Albero pompa: acciaio inox Aisi 304 (Aisi 420 F per K 50-100)
- Tenuta meccanica: carbone-ceramica

MOTORE

I motori di comando sono del tipo asincrono a gabbia di scoiattolo chiusi, a ventilazione esterna

- Motoprotettore incorporato e condensatore permanentemente inserito per i tipi monofasi
- La protezione del motore nella versione trifase è a cura del cliente e si raccomandano apparecchiature in accordo con le norme vigenti
- Isolamento classe F – servizio S1- grado di protezione IP 44
- Protezione morsettiera IP 54

ÉLECTROPOMPES CENTRIFUGES À UNE ROUE

Les électropompes centrifuges à une roue de la série K, ont été conçues pour pomper des liquides, sans parties abrasives, sans corps liquides en suspension, non explosifs ou agressifs pour les matériaux de la pompe

- Température max. du liquide jusqu'à 35 °C pour utilisation domestique (CEI EN 60335-2-41) ou 90 °C pour d'autres utilisations et température ambiante jusqu'à 40 °C.
- Plage d'utilisation jusqu'à 18 m³/h.
- Hauteur manométrique jusqu'à ~ 60 m.

CARACTERISTIQUES DE CONSTRUCTION

- Corps de pompe : En fonte G20 avec traitement anti-corrosion
- Lanterne: aluminium moulé sur pression UNI 5076 (en fonte pour K 150÷550)
- Turbine: Technopolymère (laiton étampé UNI- EN 12165 pour K 150-550)
- Abris de pompe: acier inox Aisi 304 (Aisi 420 F pour K 50-100)
- Garniture mécanique: Carbone dur - Céramique

MOTOR

Le moteurs sont asynchrones à cage d'écurieil fermés à ventilation extérieure monofásicos,

- Pour le modèles monophasés son avec protection thermique et condensateur connecté en permanence
- Pour les modèles triphasés, la protection est à la charge de l'utilisateur. A recommandé l'équipement conformément à la réglementation
- A Classe d'isolation F - service S 1 – protection IP44
- Protection IP54 dans le terminal

CENTRIFUGAL ELECTRIC PUMPS ONE IMPELLER

The close-coupled centrifugal electric pumps with one impeller series K have been designed to pump clear liquids, without abrasives and suspended solids, non-explosive or aggressive for the pump's materials

- Liquid temperature not higher than 35 °C for domestic use (CEI EN 60335-2-41) or 90 °C for other use, while the ambient temperature must not be higher than 40 °C
- Flow rate up to ~ 18 m³/h
- Heads up to ~ 60

TECHNICAL FEATURES

- Pump body: cast iron G20 with anti-corrosive coating
- Motor bracket: in die casting aluminium UNI 5076 (cast iron for K 150-550)
- Impeller: Techno-polymer (stamped brass UNI- EN 12165 for K 150-550)
- Pump shaft: stainless steel Aisi 304 (Aisi 420 F for K 50-100)
- Mechanical seal: carbon-ceramics

MOTOR

The control motors are asynchronous, squirrel cage-type, closed, with external ventilation

- Incorporated motor protection and capacitor always on, for single-phase models
- The motor protection for three-phase models must be installed by the customer. Equipment compliant with current standards should be used
- Class of insulation:F-service:S1-Degree of protection: IP 44
- Terminal board protection: IP 54

ELECTROBOMBAS CENTRÍFUGAS MONOIMPULSOR

Las electrobombas centrifugas con monoimpulsor de la serie K, han sido proyectadas para bombear líquidos, sin partes abrasivas, sin cuerpos sólidos en suspensión, que no sean explosivos ni agresivos para los materiales de la bomba.

- Temperatura max. del líquido hasta 35 °C para uso doméstico (CEI EN 60335-2-41) o 90 °C para otros usos y temperatura ambiente hasta 40 °C.
- Caudal hasta 18 m³/h.
- Alturas hasta ~ 60 m.

CARACTERÍSTICAS DE CONSTRUCCIÓN

- Cuerpo de bomba: Fundición gris G20 con tratamiento contra-corrosión
- Soporte: fundición de aluminio UNI 5076 (Fundición gris para las K 150÷550)
- Rodete: De tecnopolimero (De latón UNI- EN 12165 para las 150÷550)
- Eje de la bomba: de acero Inox AISI 304 (Aisi 420 F para las K 50÷100)
- Cierre mecánico: De cerámica y grafito

MOTOR

Los motores de accionamiento son asincrono de jaula de ardilla cerrados, ventilados externamente

- Para los modelos monofásicos, protección térmica y condensador incorporado
- Para los modelos trifásicos de la protección se encarga el usuario y el equipo recomendado de acuerdo con las normas
- Aislamiento de Clase F – funcionamiento S1- proteccion IP44
- Proteccion IP54 para el terminal

50 Hz - min⁻¹ ~ 2900

TIPO TYPE		Potenza nominale Nominal power		Potenza assorbita Input power [W]		Condensatore Capacitor 450 V max	Corrente assorbita Input current [A]			Portata - Capacity								
Monofase Single-phase	Trifase Three-phase	kW	HP	a	b	[µF]	1-230V	3-230V	3-400V	Q [m ³ /h]	0	1,2	2,4	3,6	4,8	6	7,8	
a	b									Q [l/1']	0	20	40	60	80	100	130	
K 50 M	K 50 T	0,37	0,5	680	710	12,5	2,6	1,9	1,1	Prevalenza (m C.A.) Total head (m W.C.)								
K 80 M	K 80 T	0,6	0,8	1170	1040	16	4,8	3,2	1,8	H [m]	20,0	19,5	18,0	16,0	12,5	8,5		
K 100 M	K 100 T	0,75	1	1450	1490	25	5,8	4	2,3	H [m]	30,0	29,0	28,0	25,5	22,5	18		
										H [m]	33,0	32,0	30,5	28,0	25,0	20,5	12,5	

a) - Monofase 230 V

b) - Trifase 230/400 V

TIPO TYPE		Potenza nominale Nominal power		Potenza assorbita Input power [W]		Condensatore Capacitor 450 V max	Corrente assorbita Input current [A]			Portata - Capacity								
Monofase Single-phase	Trifase Three-phase	kW	HP	a	b	[µF]	1-230V	3-230V	3-400V	Q [m ³ /h]	0	2,4	4,8	7,2	9	10,2	10,8	
a	b									Q [l/1']	0	40	80	120	150	170	180	
K 151 M	K 151 T	1,1	1,5	1980	1990	31,5	9	6	3,5	Prevalenza (m C.A.) Total head (m W.C.)								
K 200 M	K 200 T	1,47	2	2730	2630	45	12	8,3	4,8	H [m]	41,0	40,0	36,8	30,0	20,0			
K 300 M	K 300 T	2,2	3	3100	2970	55	13,6	8,9	5,1	H [m]	47,4	45,9	41,3	33,7	24,2	16,1	10	
										H [m]	52,9	51,5	47,2	40,1	32,8	24	19,5	

a) - Monofase 230 V

b) - Trifase 230/400 V

TIPO TYPE		Potenza nominale Nominal power		Potenza assorbita Input power [W]		Condensatore Capacitor 450 V max	Corrente assorbita Input current [A]			Portata - Capacity							
Monofase Single-phase	Trifase Three-phase	kW	HP	a	b	[µF]	1-230V	3-230V	3-400V	Q [m ³ /h]	0	3	6	9	12	15	18
a	b									Q [l/1']	0	50	100	150	200	250	300
K 400 M	K 400 T	3	4	4180	4470	70	18	13,5	7,8	Prevalenza (m C.A.) Total head (m W.C.)							
-	K 550 T	4	5,5	-	5860	-	-	19	10,2	H [m]	48,5	48,0	48,0	46,0	42,0	38	32
										H [m]	61,0	61,0	60,0	59,0	57,0	54	49,5

a) - Monofase 230 V

b) - Trifase 230/400 V

60 Hz - min⁻¹ ~ 3400

TIPO TYPE		Potenza nominale Nominal power		Potenza assorbita Input power [W]		Condensatore Capacitor 450 V max	Corrente assorbita Input current [A]				Portata - Capacity							
Monofase Single-phase	Trifase Three-phase	kW	HP	a	b	[µF]	1-115V	1-220V	3-220V	3-380V	Q [m ³ /h]	0	1,2	2,4	3,6	4,8	6	7,8
a	b										Q [l/1']	0	20	40	60	80	100	130
K 50 M	K 50 T	0,37	0,5	720	760	16	6,6	2,2	2,1	1,3	Prevalenza (m C.A.) Total head (m W.C.)							
K 80 M	K 80 T	0,6	0,8	1160	1190	20	9,5	3,2	3,3	1,8	H [m]	21,5	20,6	19,0	16,9	13,6	10,3	
K 100 M	K 100 T	0,75	1	1230	1520	20	13	4	4	2,3	H [m]	31,5	30,0	28,0	26,0	24,0	19,0	
											H [m]	33,5	32,5	31,0	29,0	27,0	24	16

a) - Monofase 115/220 V

b) - Trifase 220/380 V

TIPO TYPE		Potenza nominale Nominal power		Potenza assorbita Input power [W]		Condensatore Capacitor 450 V max	Corrente assorbita Input current [A]			Portata - Capacity								
Monofase Single-phase	Trifase Three-phase	kW	HP	a	b	[µF]	1-220V	3-220V	3-380V	Q [m ³ /h]	0	2,4	4,8	7,2	9	10,2	10,8	
a	b									Q [l/1']	0	40	80	120	150	170	180	
K 151 M	K 151 T	1,1	1,5	1990	2120	31,5	6	6,9	3,5	Prevalenza (m C.A.) Total head (m W.C.)								
K 201 M	K 201 T	1,47	2	2500	2630	45	11,5	7,3	4,2	H [m]	38,0	37,8	35,0	26,0	12,5			
-	K 300 T	2,2	3	-	3120	-	-	9,8	5,3	H [m]	47,6	47,0	44,3	33,8	23,6	10,0		
										H [m]	51,6	50,0	46,8	41,4	34,8	24,1	16,4	

a) - Monofase 220 V

b) - Trifase 220/380 V

TIPO TYPE		Potenza nominale Nominal power		Potenza assorbita Input power [W]		Condensatore Capacitor 450 V max	Corrente assorbita Input current [A]			Portata - Capacity							
Monofase Single-phase	Trifase Three-phase	kW	HP	a	b	[µF]	1-220V	3-220V	3-380V	Q [m ³ /h]	0	3	6	9	12	15	18
a	b									Q [l/1']	0	50	100	150	200	250	300
-	K 400 T	3	4	4530	4530	-	-	14	6,8	Prevalenza (m C.A.) Total head (m W.C.)							
K 550 M	K 550 T	4	5,5	5400	5700	60	26,2	17	8	H [m]	49,5	48,0	47,0	44,5	42,0	38,7	34
										H [m]	57,0	56,0	54,0	51,5	49,0	45	41

b) - Trifase 220/380 V

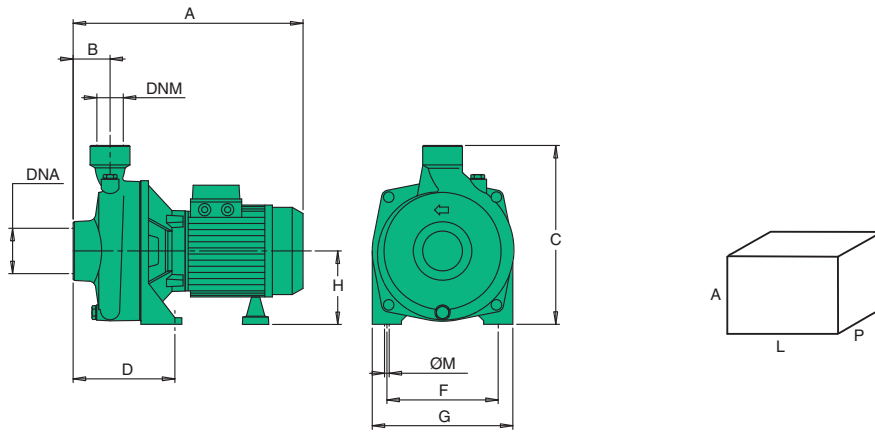

TIPO TYPE	DIMENSIONI [mm] DIMENSIONS [mm]										IMBALLO [mm] PACKING [mm]			PESO WEIGHT [kg]
	A	B	C	D	F	G	Ø	H	DNA	DNM	A	L	P	
K 50	265	45	206	103	124	164	9	85	1"	1"	170	300	250	9,2
K 80	283	45	237	105	140	180	9	97	1"	1"	280	330	200	11,2
K 100	283	45	237	105	140	180	9	97	1"	1"	280	330	200	12,4
K 151	344	47	262	107	149	199	11	110	1" 1/4	1"	320	350	220	20,8
K 201	344	47	262	107	149	199	11	110	1" 1/4	1"	320	350	220	22,8
K 200	373	52	294	30	160	223	11	118	1" 1/4	1"	350	450	260	25,2
K 300	373	52	294	30	160	223	11	118	1" 1/4	1"	350	450	260	26,6
K 400	442	57	340	93	200	250	14	150	1" 1/2	1" 1/4	380	290	520	44,5
K 550	442	57	340	93	200	250	14	150	1" 1/2	1" 1/4	380	290	520	46,5

min⁻¹ ~ 2900

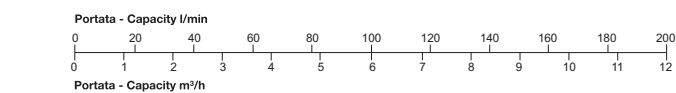
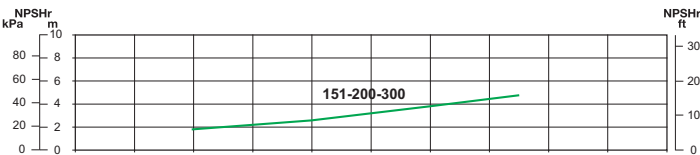
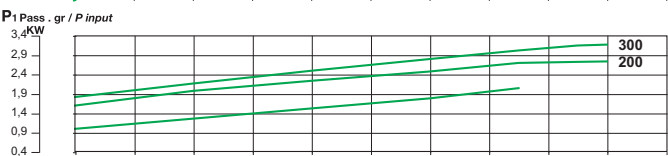
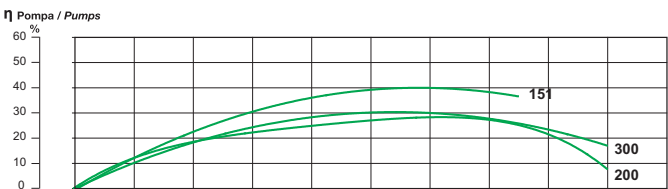
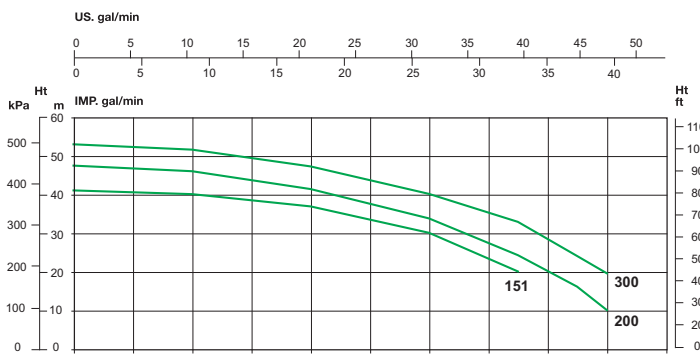
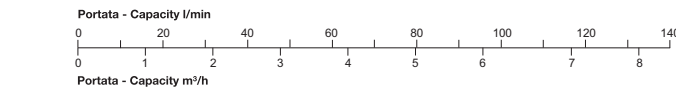
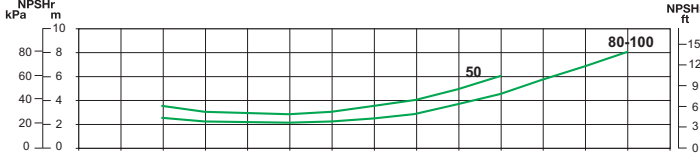
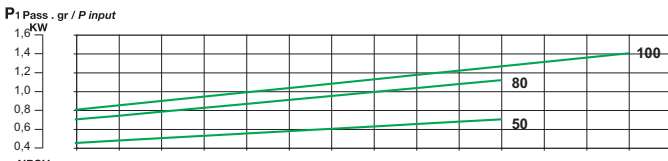
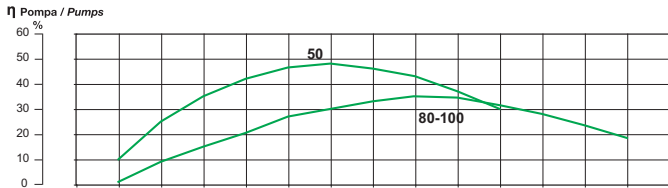
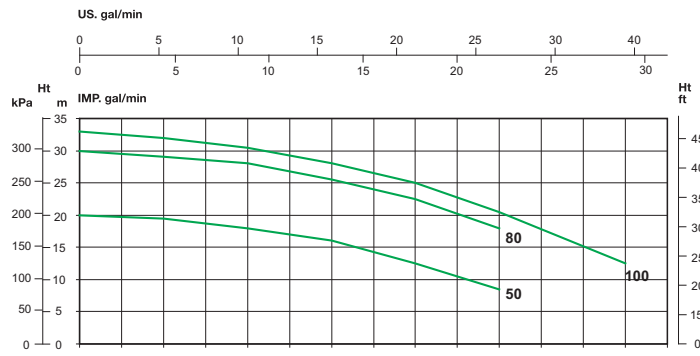

min⁻¹ ~ 3400

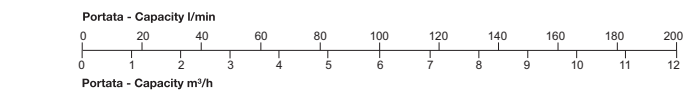
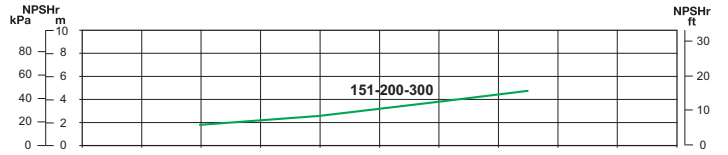
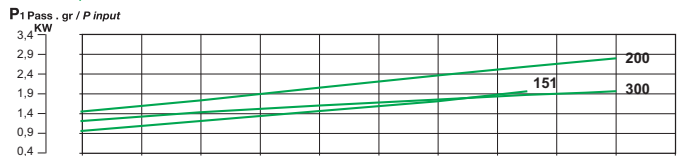
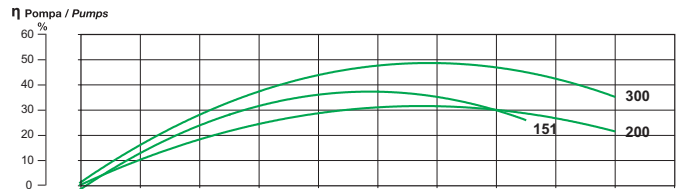
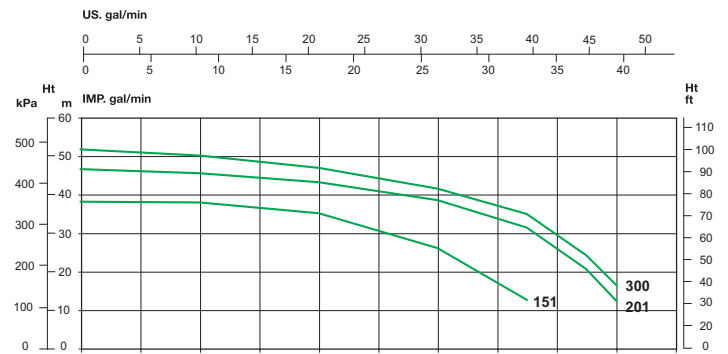
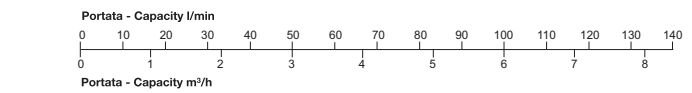
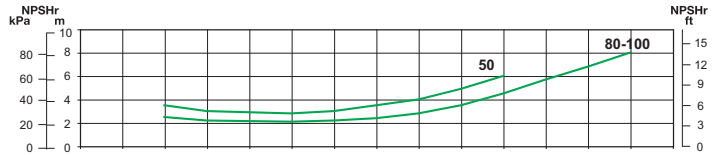
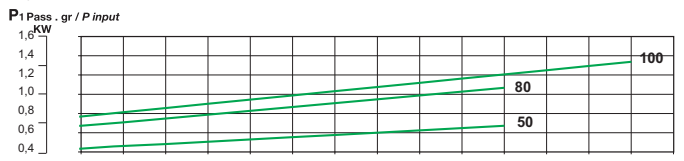
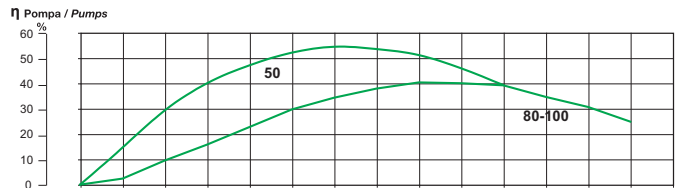
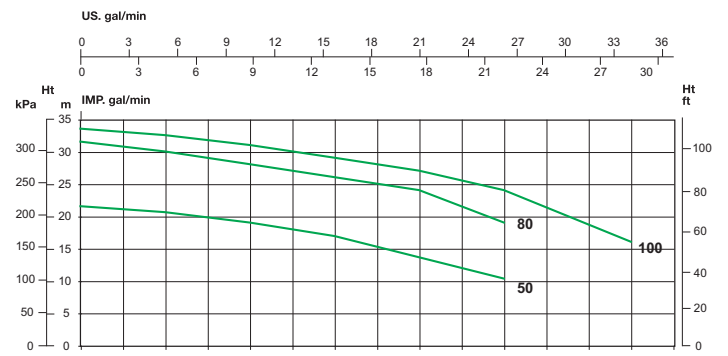

min⁻¹ ~ 2900

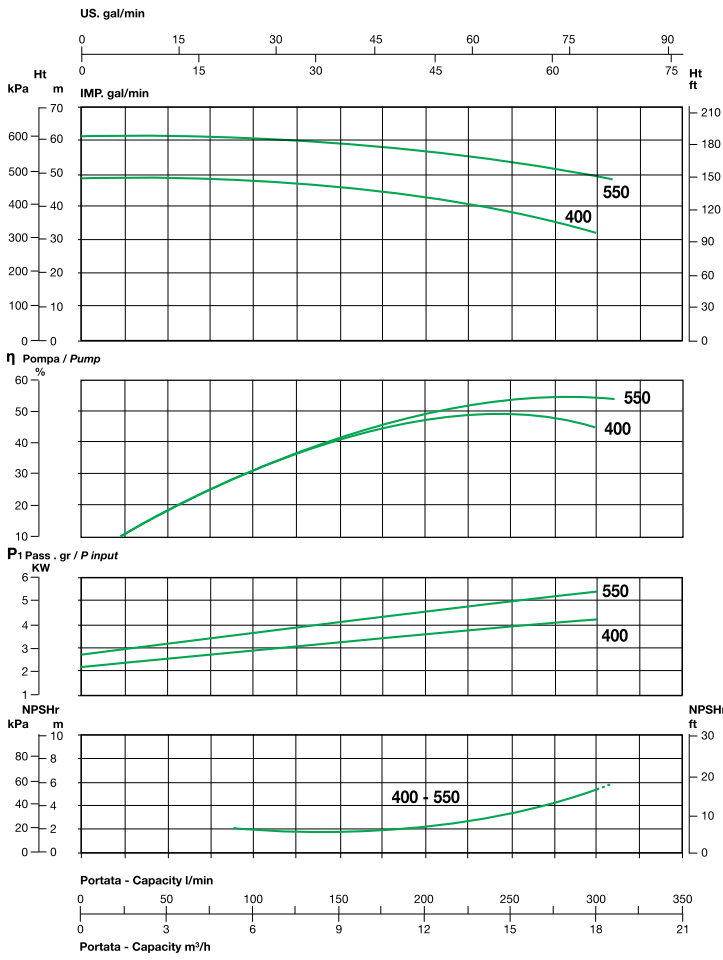

min⁻¹ ~ 3400

